

# Esteira Porta-cabos T100.35.R75

Fabricadas em Nylon - Cor padrão: Preto;  
Faixa de Temperatura: -30° ~120°C;

Sistema de abertura que facilita a troca  
e manutenção dos cabamentos;

Modelo com separador de cabos.



## Especificações Técnicas

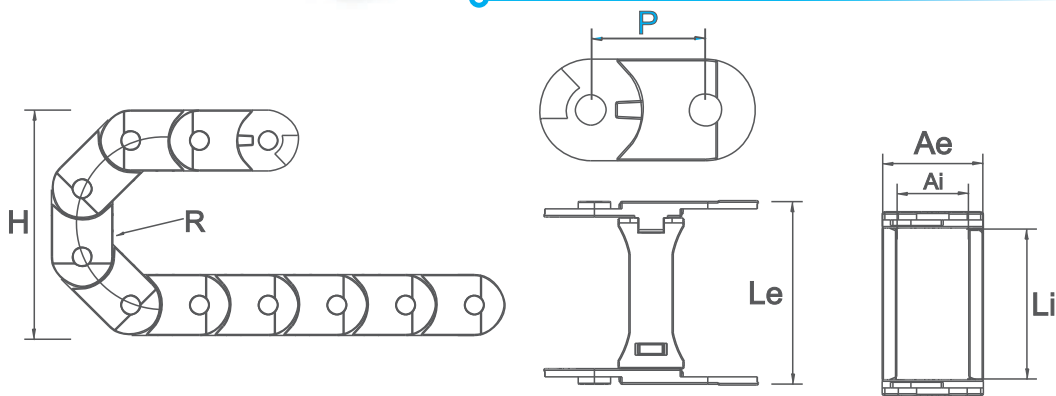

CÓDIGO	DESCRIÇÃO	MEDIDA INTERNA (Li x Ai)	MEDIDA EXTERNA (Le x Ae)	ALTURA (H)	RAIO (R)	PASSO (P)	ELO/METRO	PESO/METRO
03484	ESTEIRA PORTA CABOS T100.35 R75mm	100x35	116x50	185	75	56	18	1760gr

\*Unidade de medida: milímetros

## Separador de cabos (Cód. 03558)

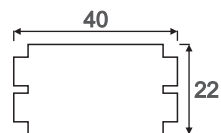

Exemplo de posição no interior do elo

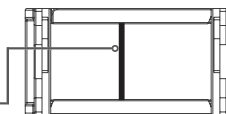

\* Recomendado utilizar  
1 separador a cada 3 elos.

## Terminal de Fixação

Cada esteira necessita de um conjunto de terminal composto de duas ponteiros, fixando uma ponteira em cada extremidade da esteira.

CÓDIGO	DESCRIÇÃO	MEDIDA INTERNA (Li x Ai)	MEDIDA EXTERNA (Le x Ae)
03485	CJ. TERMINAL T100.35	100x35	124x50

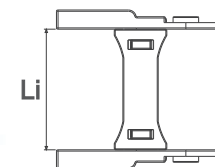
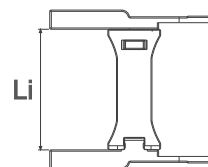
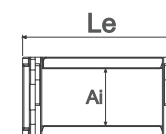
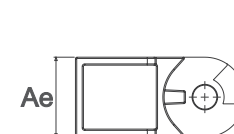
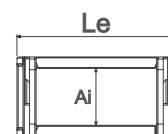
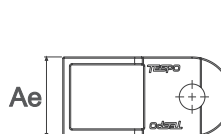

Para fixação dos terminais pode-se  
adicionar furos na área em destaque.

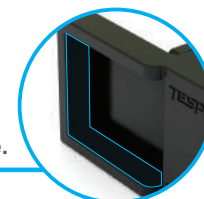

## Esquema Montagem

### Passo 1



### Passo 2



### Passo 3



### Encaixe Final



\*Chave opcional disponível  
para ajudar na montagem.  
(Cód.03684)

